

Serie G-200

Lüftungsgitter zweireihig mit verstellbaren vertikalen (hinten) und horizontalen (vorne) Lamellen für Kanaleinbau. Gitter und Anbauteile aus verzinktem Stahlblech mit Senkbohrungen für Schraubenmontage.

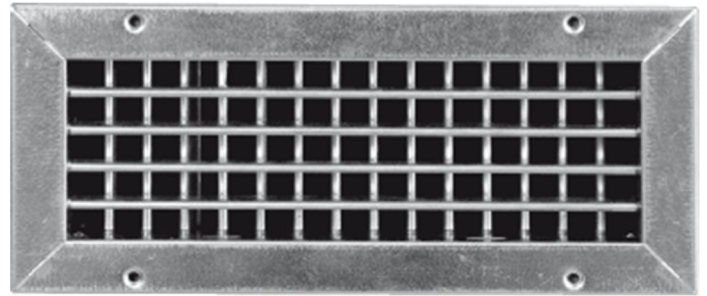

Optional:







- Ohne Senkbohrungen mit Einbaurahmen und Klemmfedern (nicht für Deckenmontage geeignet).
- Lackierung in RAL- und NCS-Farben auf Anfrage.
- Masse und Ausführungen nach Vorgabe.

H\B	200	300	400	500	600	800	1000	1200
50	S	S	S	S	S	S	S	S
100	S	S	S	S	S	S	S	S
150	S	S	S	S	S	S	S	S
200	S	S	S	S	S	S	S	S
300		S	S	S	S	S	S	S
400			S	S	S	S	S	S
500				S	S	S	S	S

S= Standard (Alle Sondergrößen möglich, Preis auf Anfrage)

Alle Angaben in mm

Ausführungen:

-  **G-200** ohne Anbauteile
-  **G-210** mit einstellbarer Schöpfzunge
-  **G-220** mit einstellbaren Schöpflamellen
-  **G-230** mit gegenläufiger Mengenregulierung
-  **G-240** mit einstellbarem Schlitzschieber
-  **G-250** mit schrägem einstellbarem Schlitzschieber

Rücknahme oder Umtausch nicht möglich!

Lüftungsgitter Serie G-200

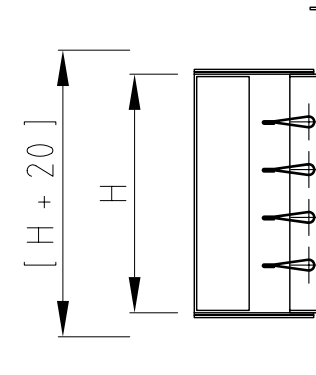
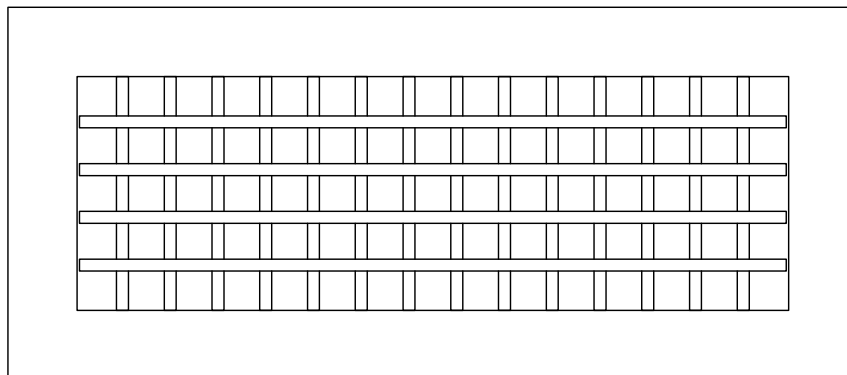
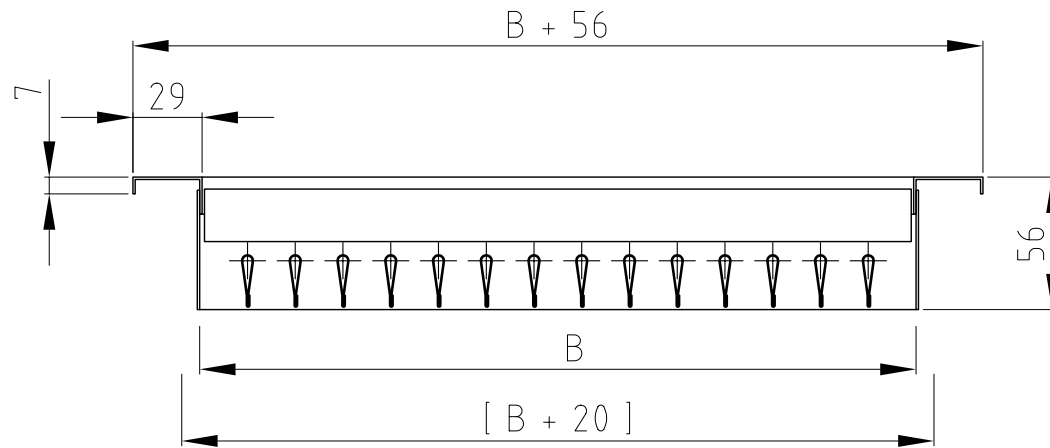

Lüftungsgitter Serie G-210

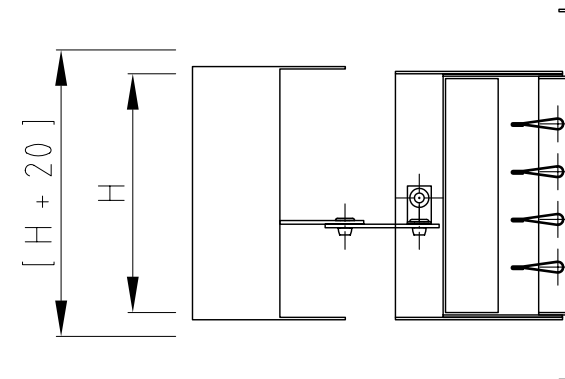
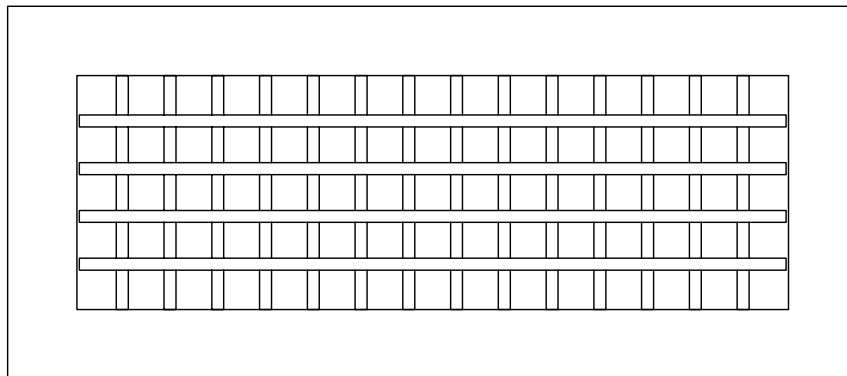
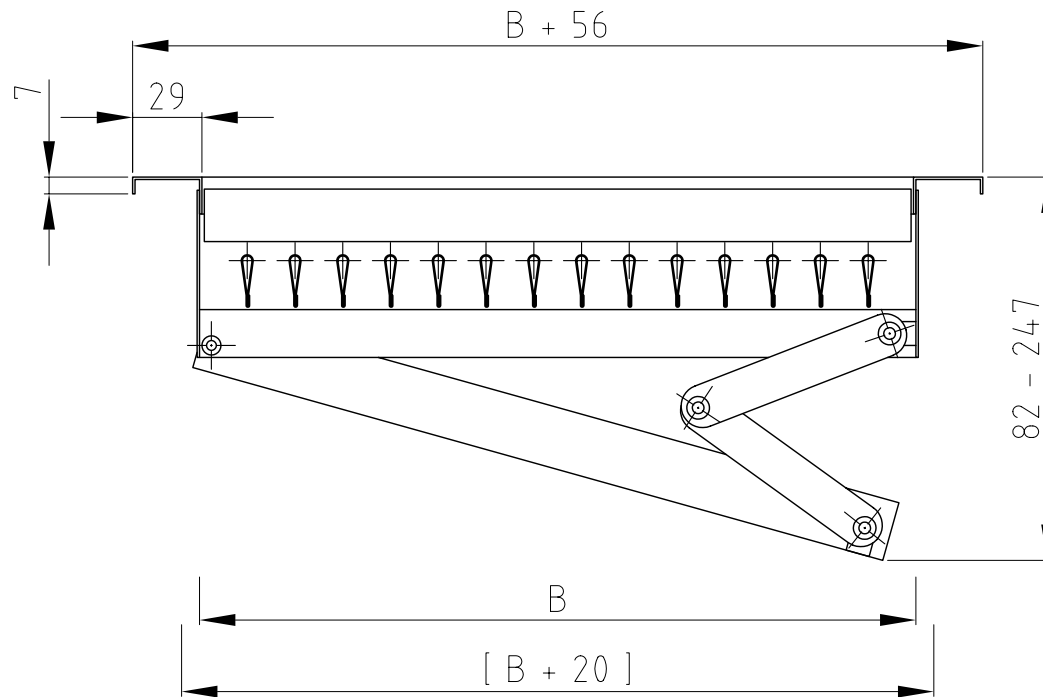

Lüftungsgitter Serie G-220

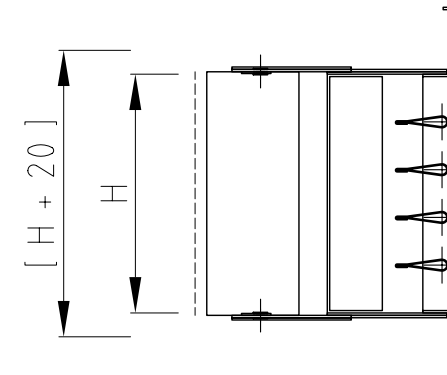
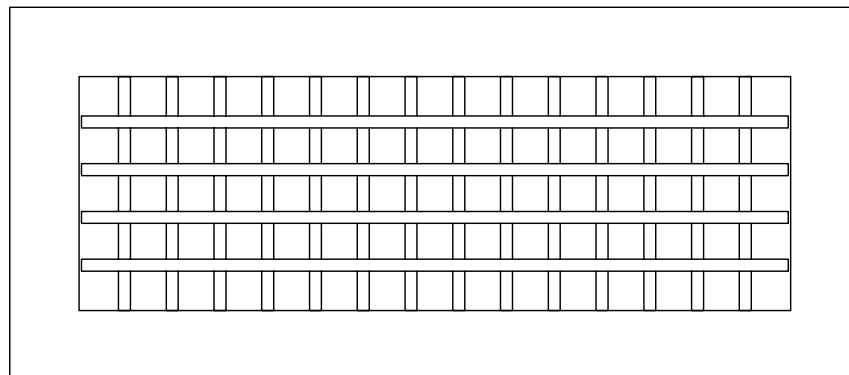
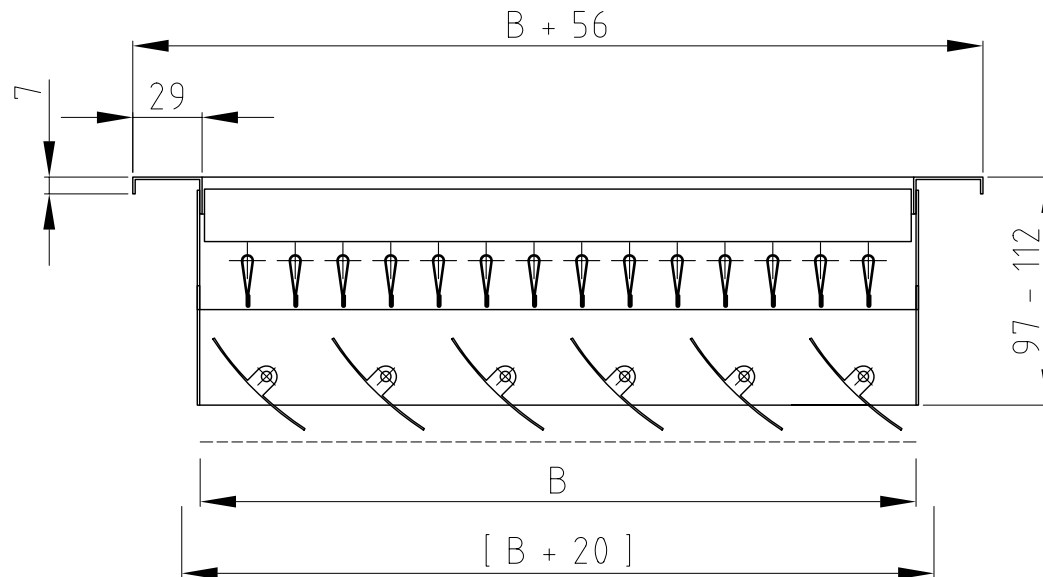

Lüftungsgitter Serie G-230

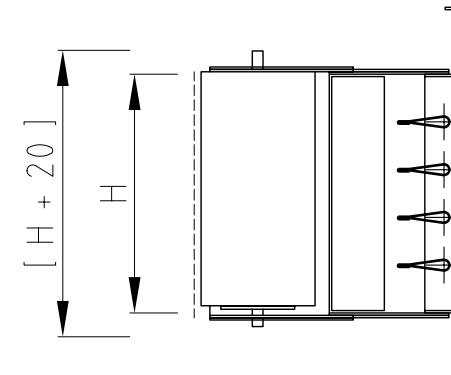
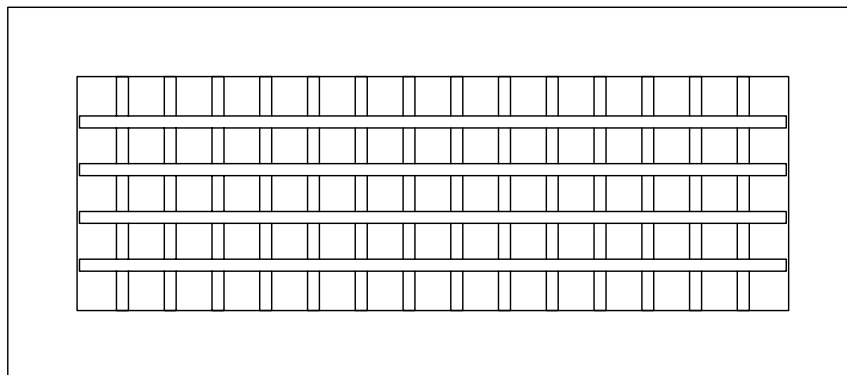
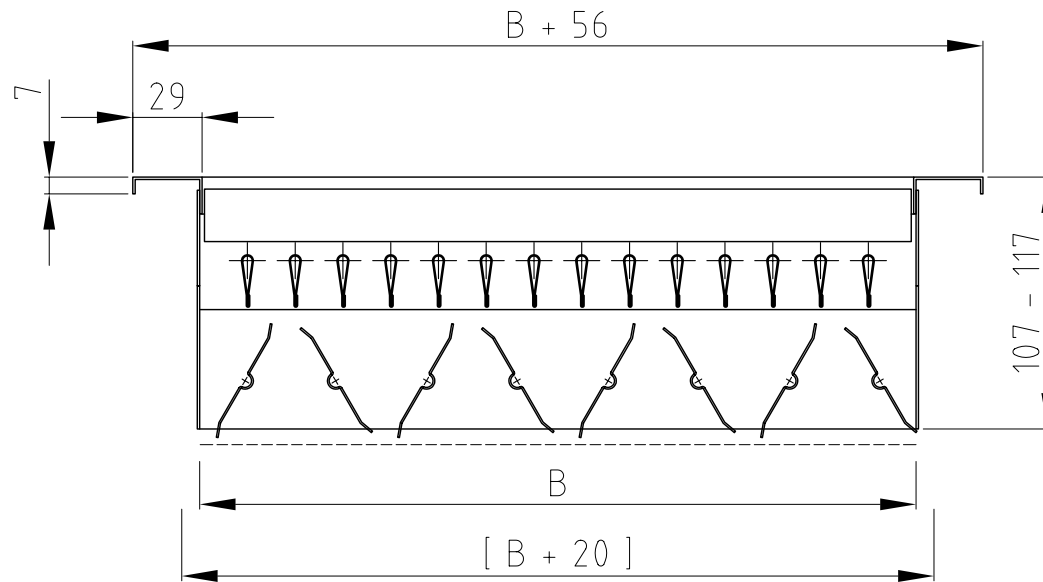

Lüftungsgitter Serie G-240

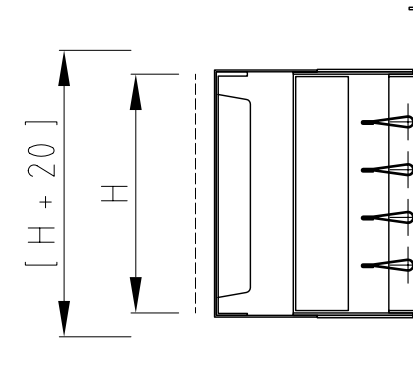
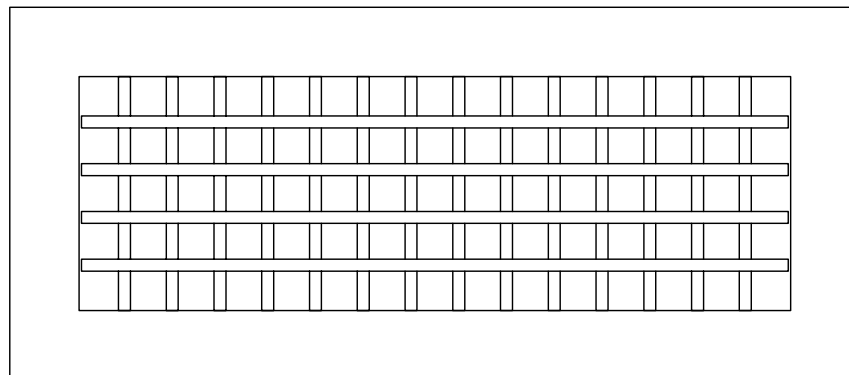
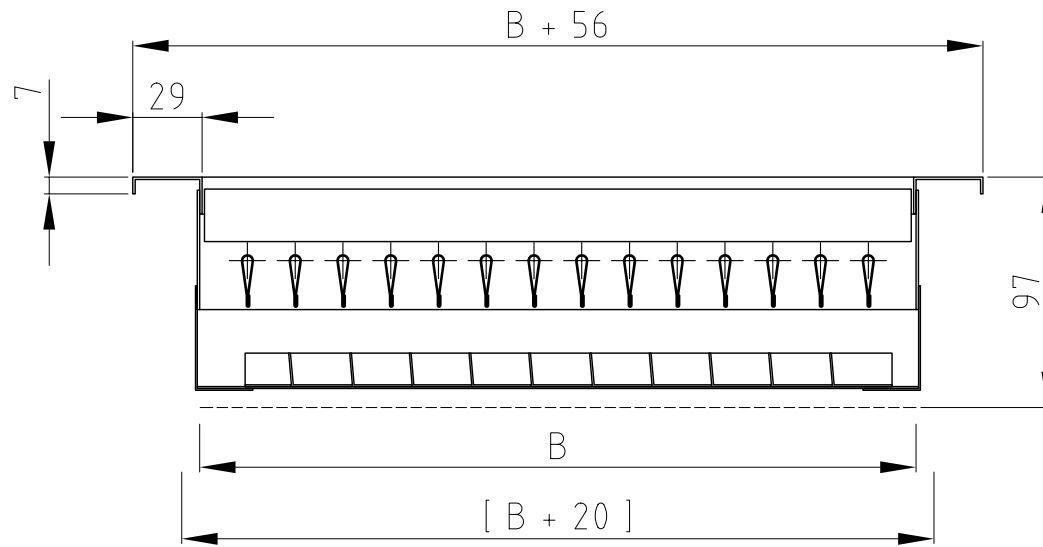

Lüftungsgitter Serie G-250

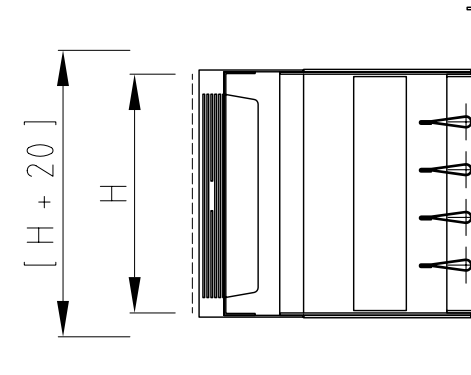
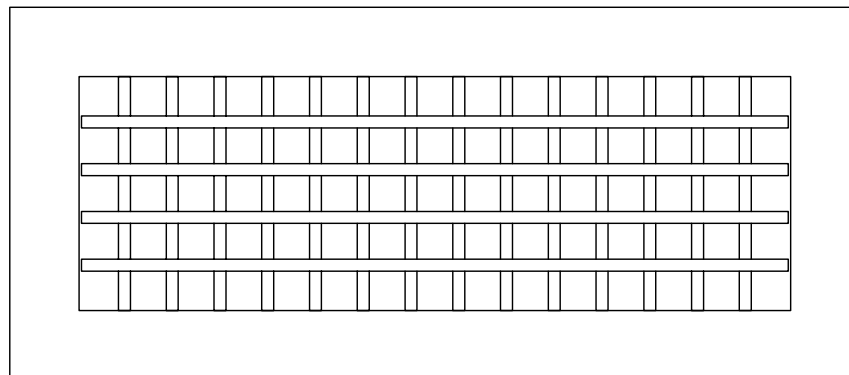
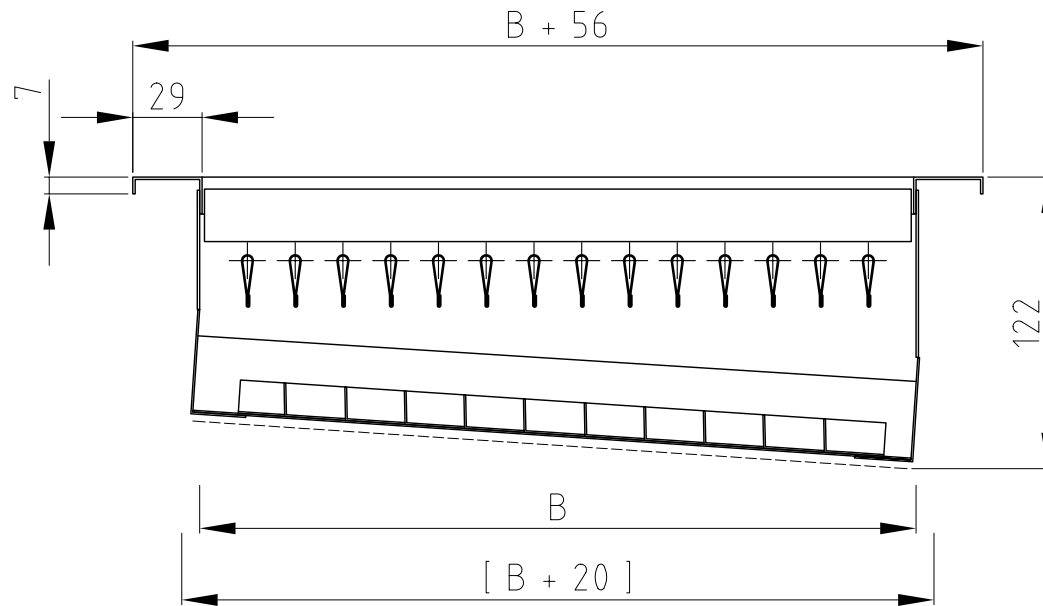

Einbaurahmen Serie ER

