

Serie G-200-R

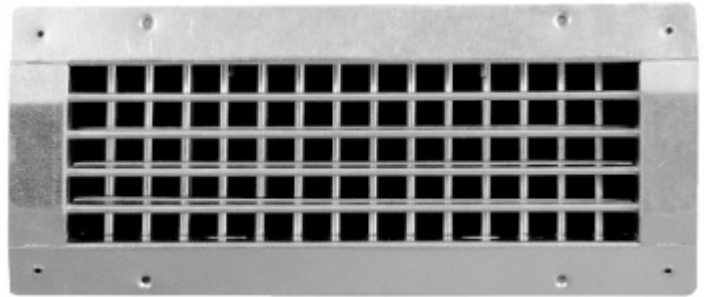

Lüftungsgitter zweireihig mit verstellbaren vertikalen (hinten) und horizontalen (vorne) Lamellen für Rohreinbau. Gitter und Anbauteile aus verzinktem Stahlblech mit Senkbohrungen für Schraubenmontage.



Optional:

- Lackierung in RAL- und NCS-Farben auf Anfrage.
- Masse und Ausführungen nach Vorgabe.

H\B (mm)	200	300	400	500	600	800	1000
50	S	S	S	S	S	S	S
100	S	S	S	S	S	S	S
150	S	S	S	S	S	S	S
200	S	S	S	S	S	S	S

S= Standard (Alle Sondergrößen möglich, Preis auf Anfrage)

Gitter Höhe (mm)	Durchmesser (mm)																								
	125	140	160	180	224	250	280	315	355	400	450	500	560	630	710	800	900	1000	1120	1250	1400	1600	1800	2000	
50																									
100																									
150																									
200																									

■ Idealer Bereich

Ausführungen:



G-200-R ohne Anbauteile



G-210-R mit einstellbarer Schöpfzunge



G-220-R mit einstellbaren Schöpflamellen

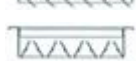

G-230-R mit gegenläufiger Mengenregulierung



G-240-R mit einstellbarem Schlitzschieber



G-250-R mit schrägem einstellbarem Schlitzschieber

Rücknahme oder Umtausch nicht möglich!

Lüftungsgitter Serie G-200 R

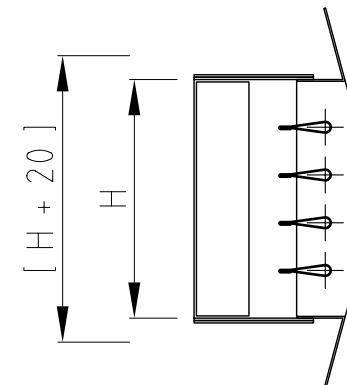
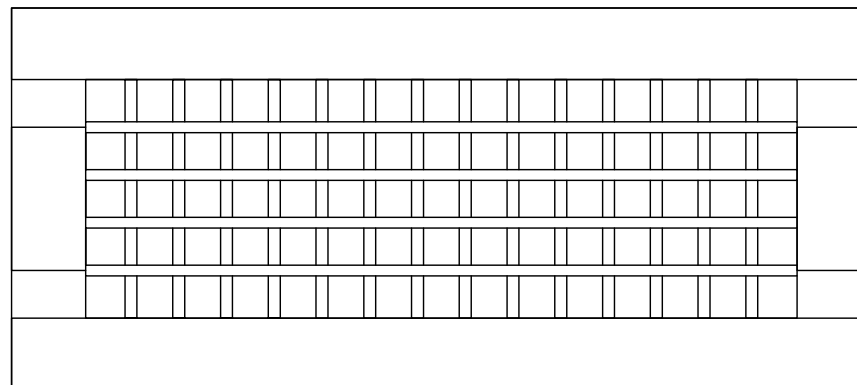
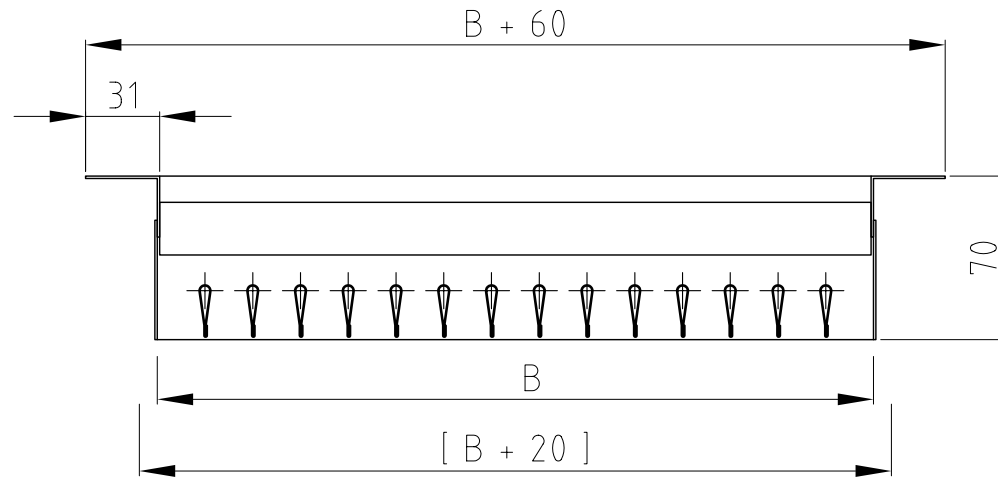

Lüftungsgitter Serie G-210 R

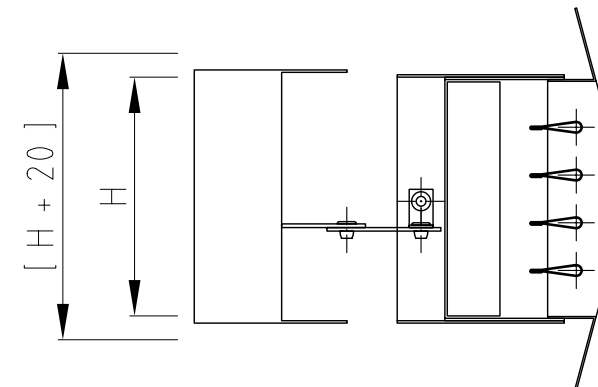
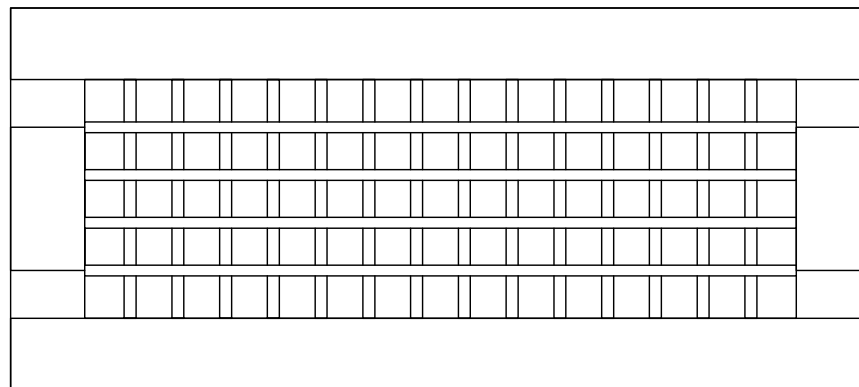
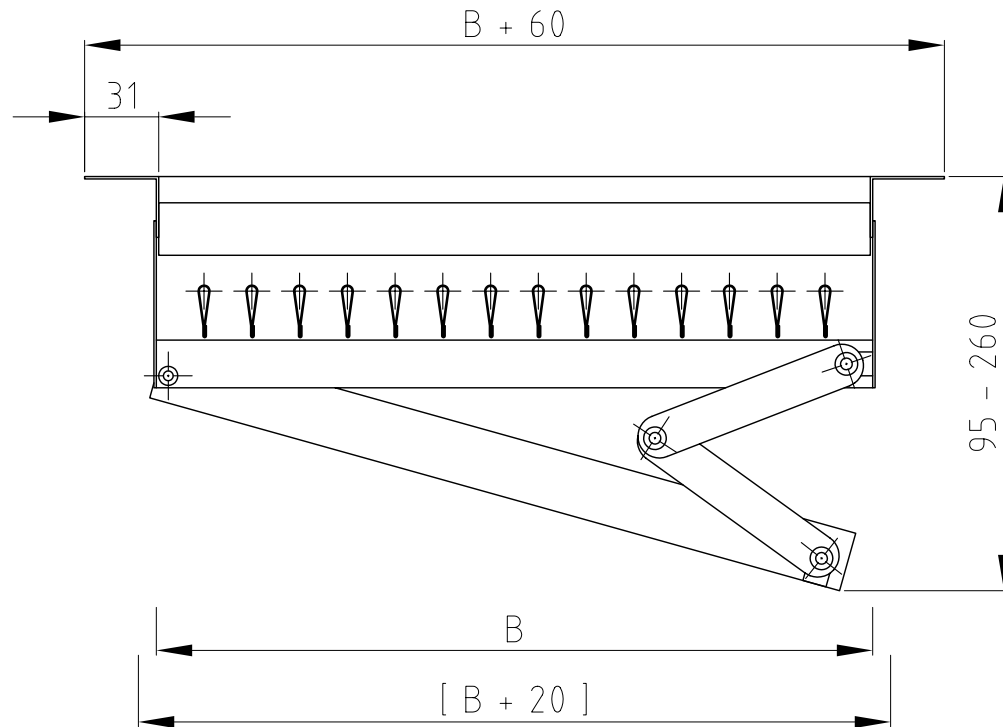

Lüftungsgitter Serie G-220 R

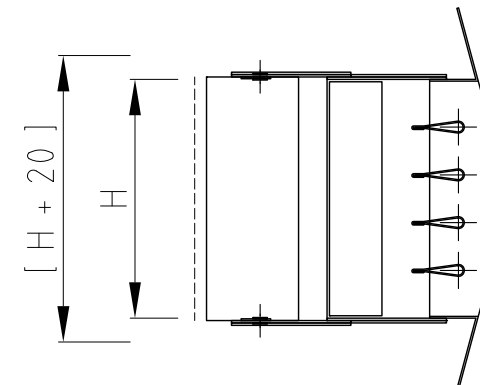
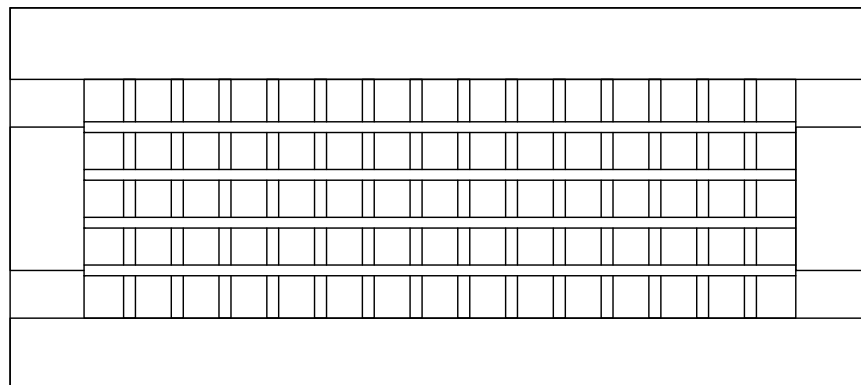
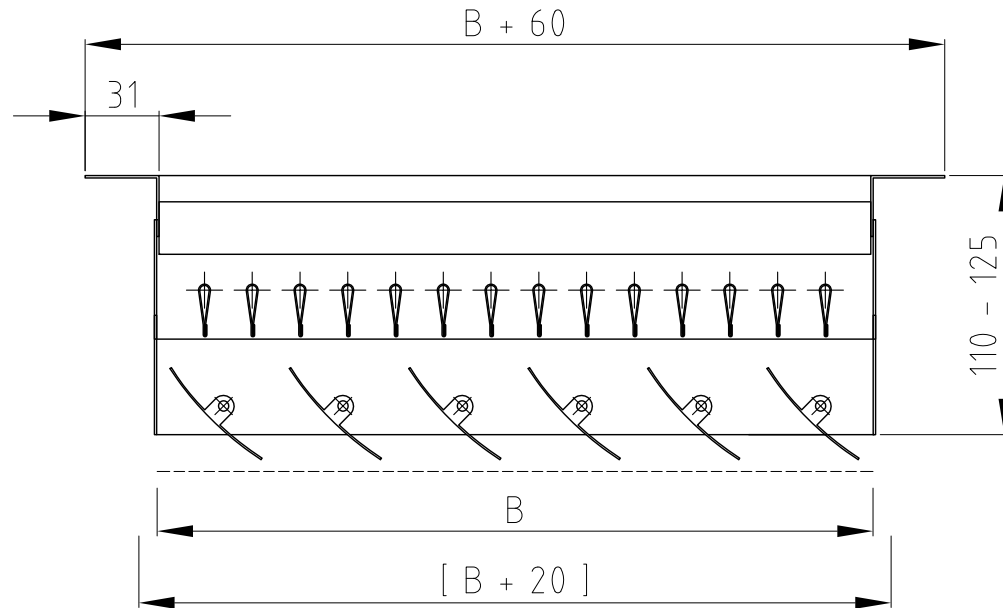

Lüftungsgitter Serie G-230 R

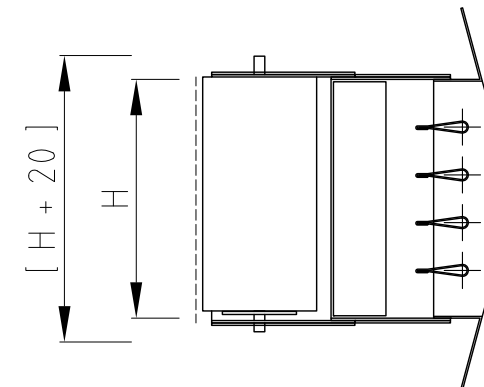
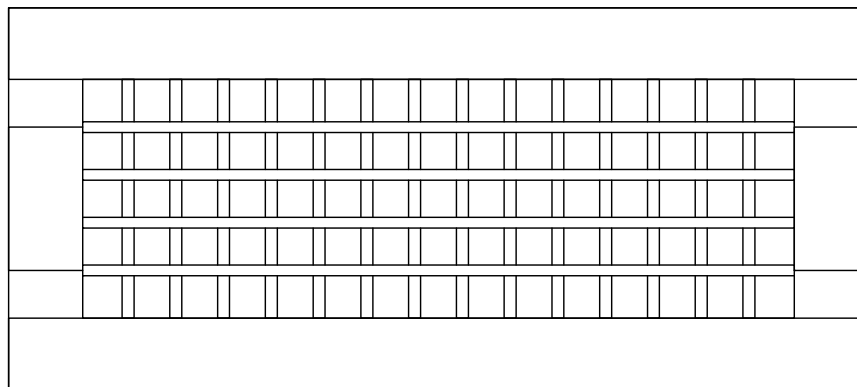
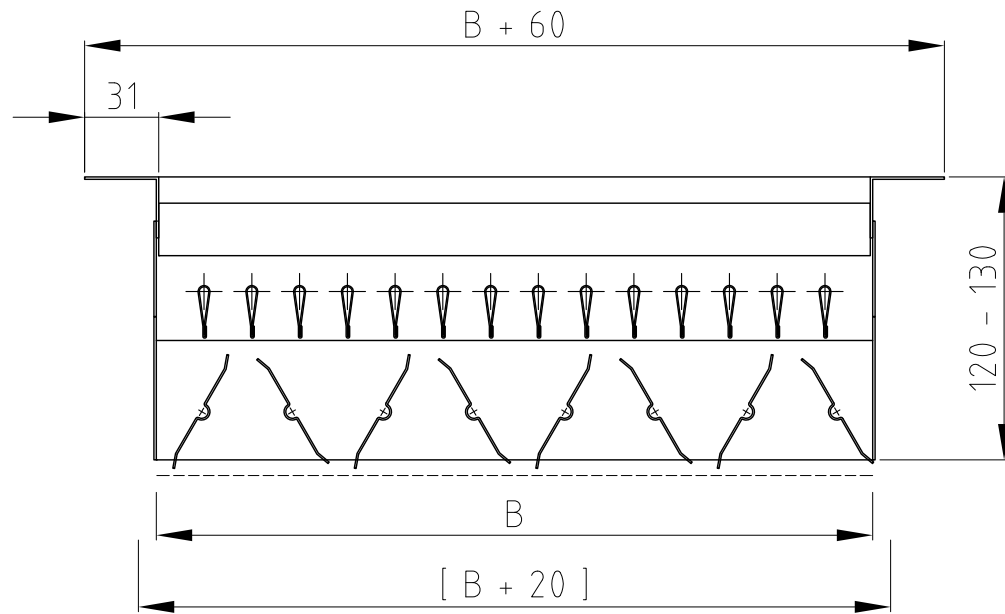

Lüftungsgitter Serie G-240 R

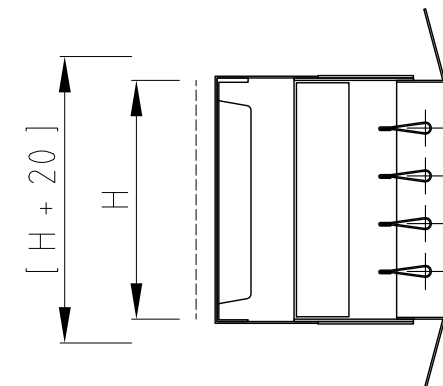
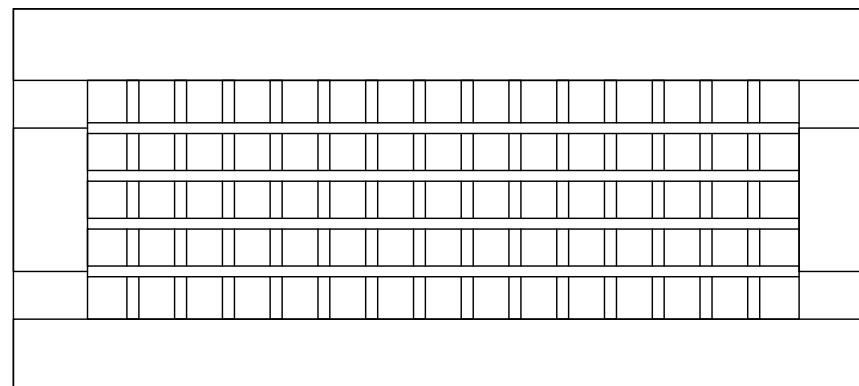
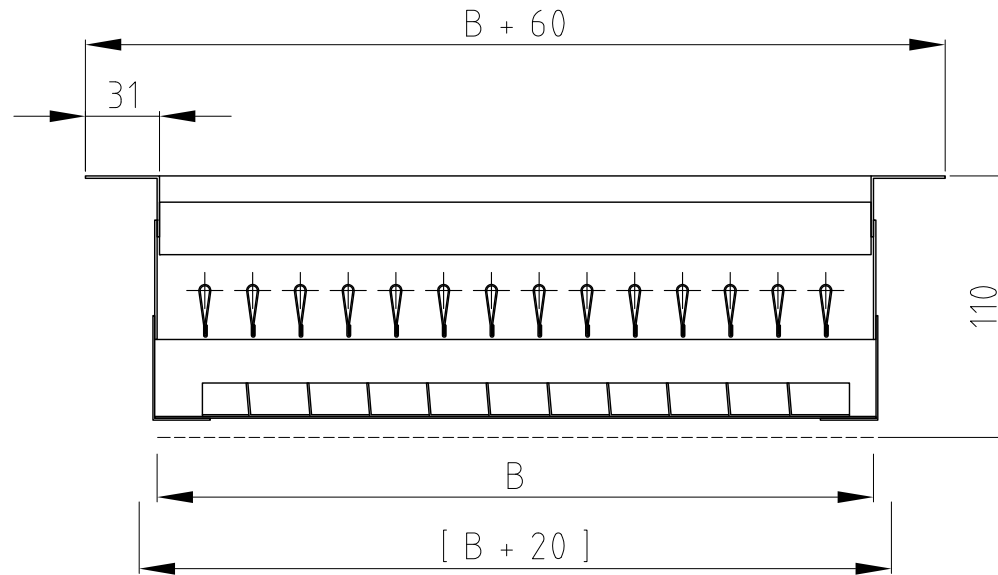

Lüftungsgitter Serie G-250 R

