

Serie AG-100

Lüftungsgitter einreihig mit verstellbaren horizontalen Lamellen. Ausführung aus roh Aluminium (Standard). Anbauteile aus verzinktem Stahlblech. Mit Senkbohrungen für Schraubenmontage.

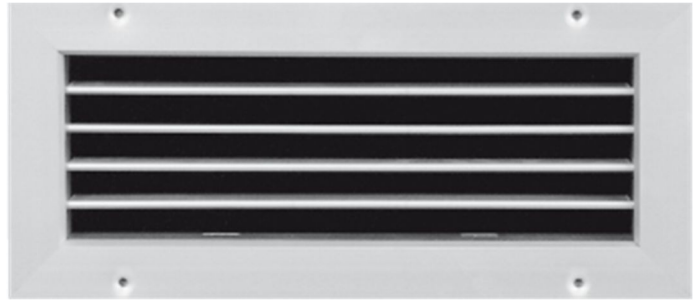

Optional:





- Aluminium Natur eloxiert
- Ohne Senkbohrungen mit Einbaurahmen und Klemmfedern (nicht für Deckenmontage geeignet).
- Lackierung in RAL- und NCS-Farben auf Anfrage.
- Masse und Ausführungen nach Vorgabe.

H\B	200	300	400	500	600	800	1000	1200
50	S	S	S	S	S	S	S	S
100	S	S	S	S	S	S	S	S
150	S	S	S	S	S	S	S	S
200	S	S	S	S	S	S	S	S
300		S	S	S	S	S	S	S
400			S	S	S	S	S	S
500				S	S	S	S	S

S= Standard (Alle Sondergrößen möglich, Preis auf Anfrage)

Alle Angaben in mm

Ausführungen:

-  **AG-100** ohne Anbauteile
-  **AG-110** mit einstellbarer Schöpfzunge
-  **AG-130** mit gegenläufiger Mengenregulierung
-  **AG-140** mit einstellbarem Schlitzschieber
-  **AG-150** mit schrägem einstellbarem Schlitzschieber

Rücknahme oder Umtausch nicht möglich!

Lüftungsgitter Serie AG-100

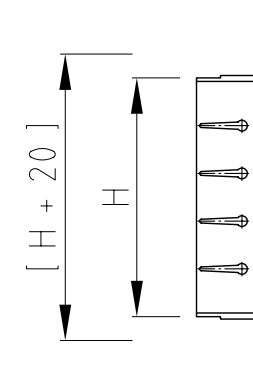
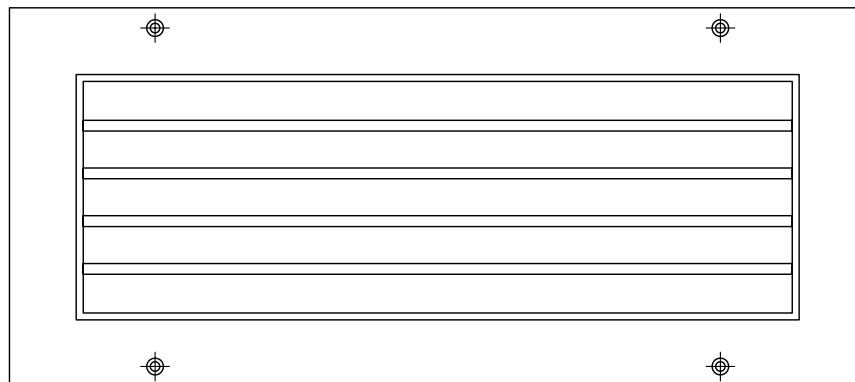
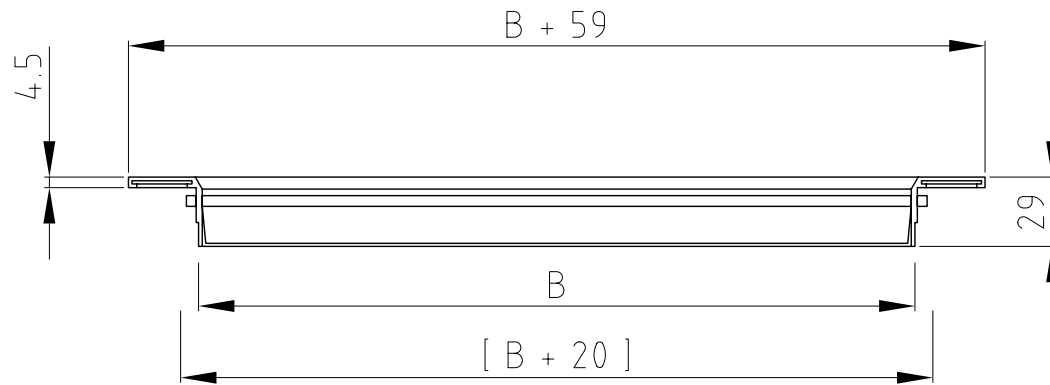

Lüftungsgitter Serie AG-110

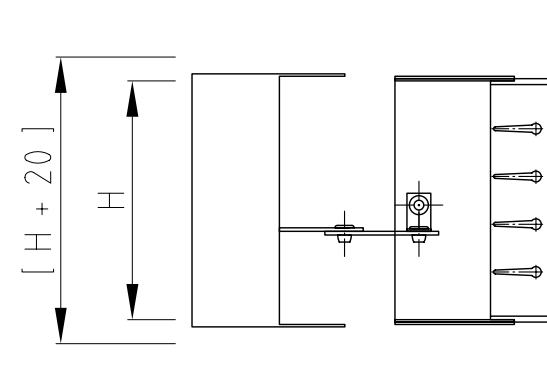
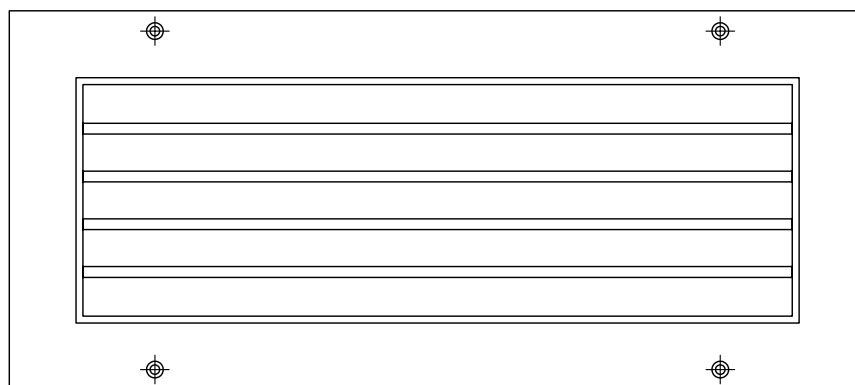
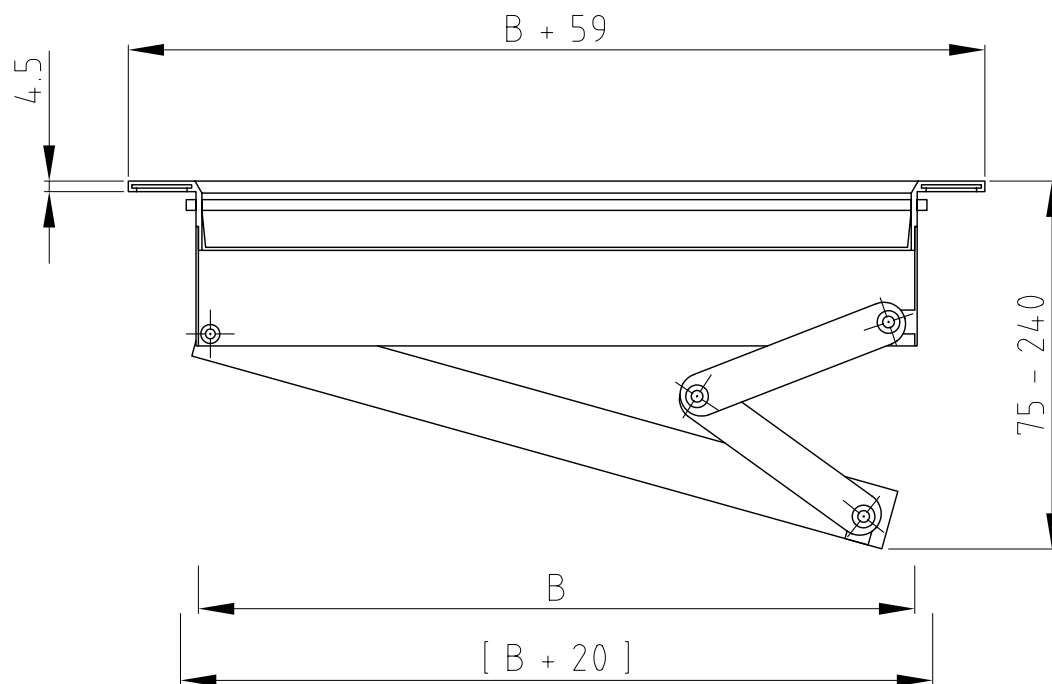

Lüftungsgitter Serie AG-130

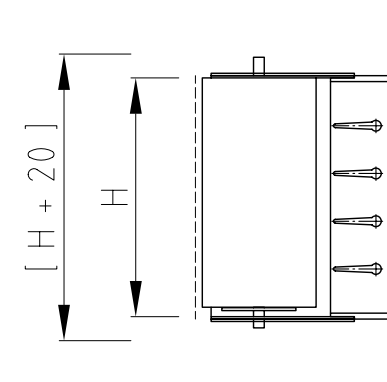
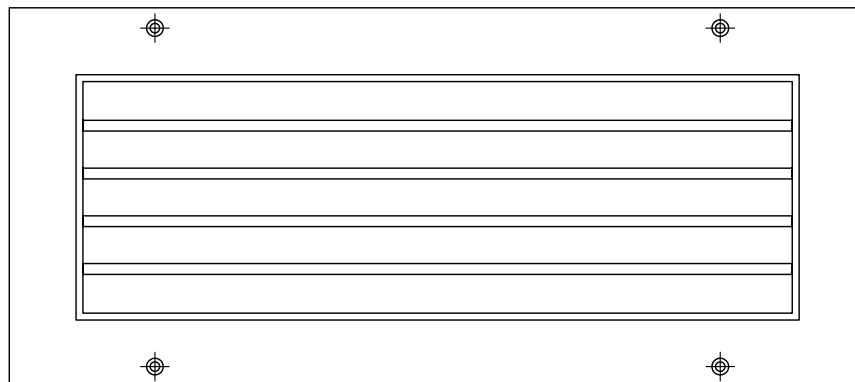
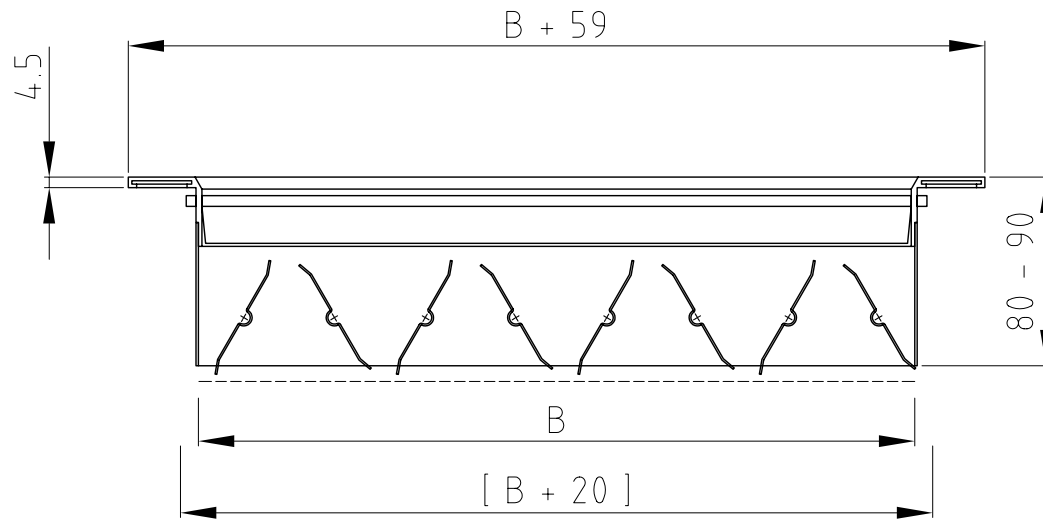

Lüftungsgitter Serie AG-140

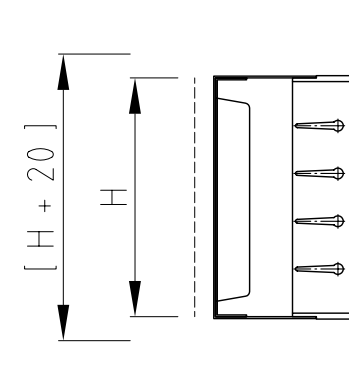
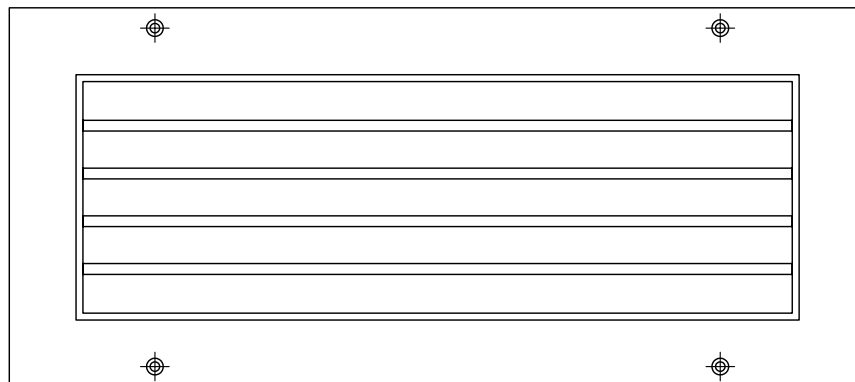
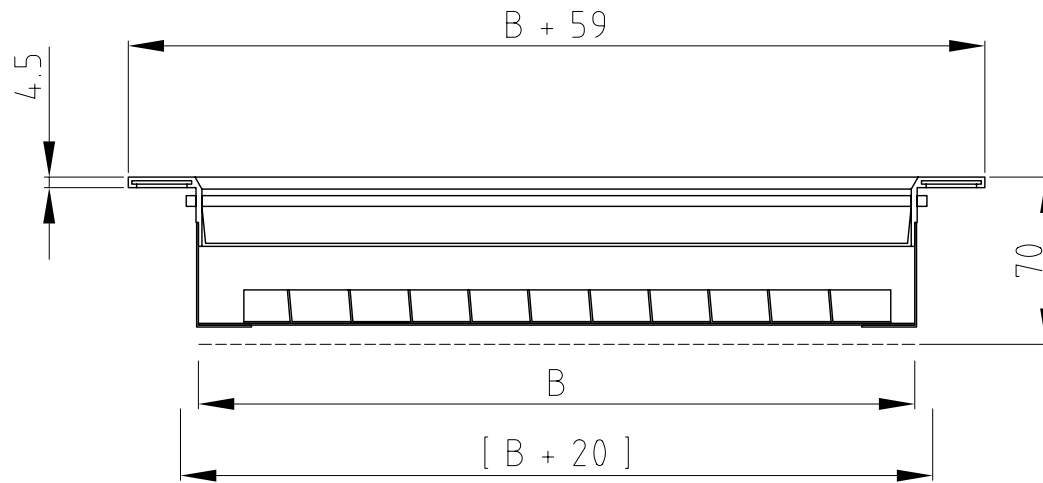

Lüftungsgitter Serie AG-150

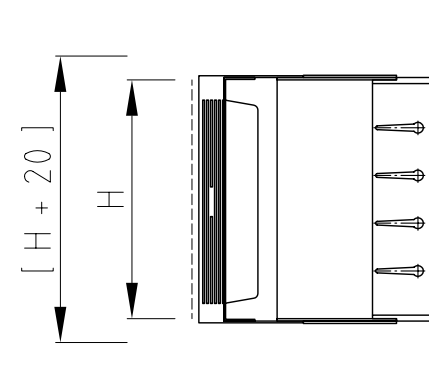
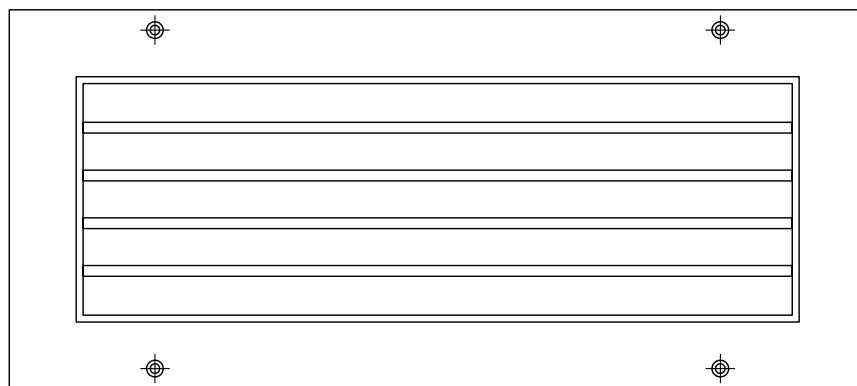
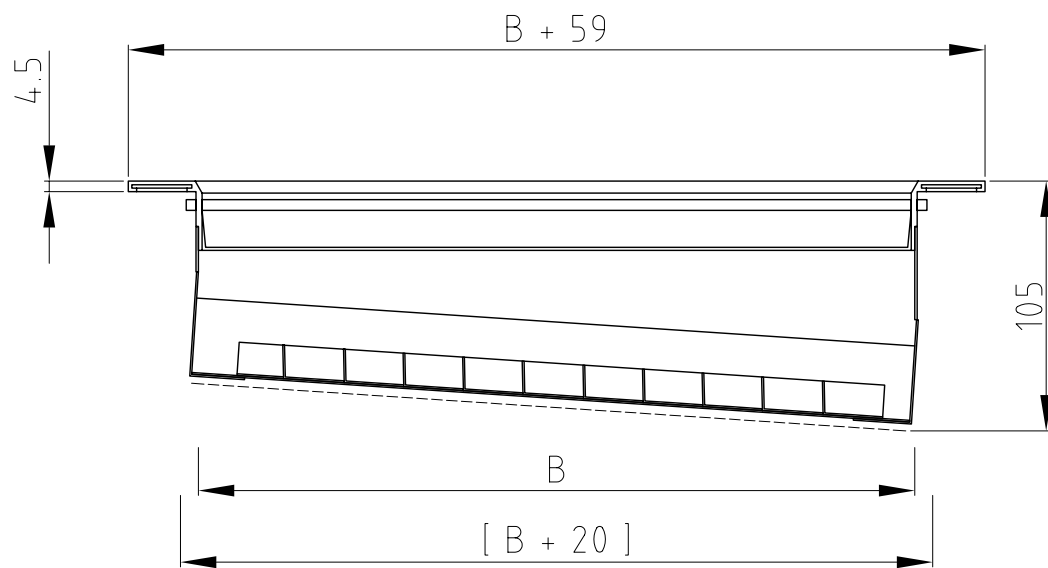

Einbaurahmen Serie ER

